



# Monteringsanvisning 2436-400

Solea & Solea Ring

ecolux

# Måttskiss Solea & Solea Ring

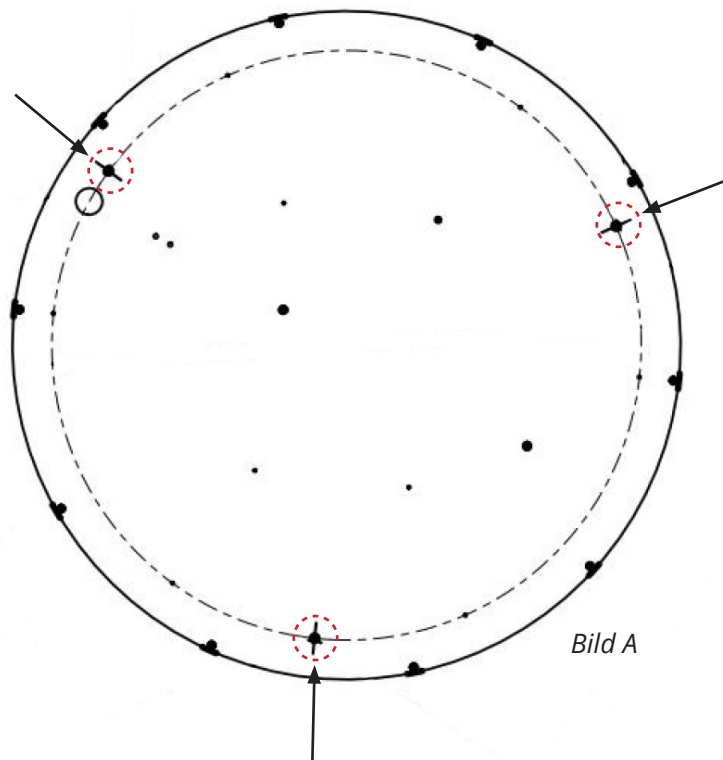
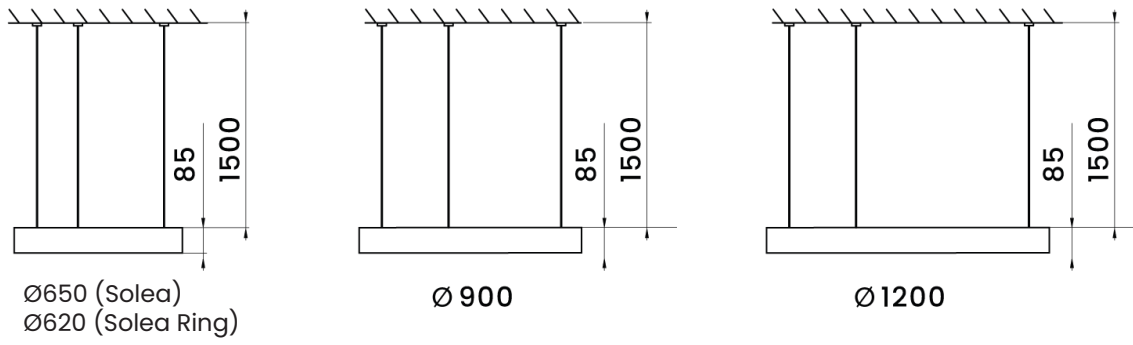

# Montage Solea & Solea Ring



OBS! Stäng av huvudströmmen innan installation.

2 personer rekommenderas vid installation.

1. Montera upp takkopp och uppfästningarna i tak.
2. Skruva fast wireupphänget (x3) i armaturhusets ovansida, se bild A.
3. Anslut kablarna i takkopp. Kontrollera att dragavlastaren är tillräckligt åtspänd.



Tryck ej på bländskyddet

1.

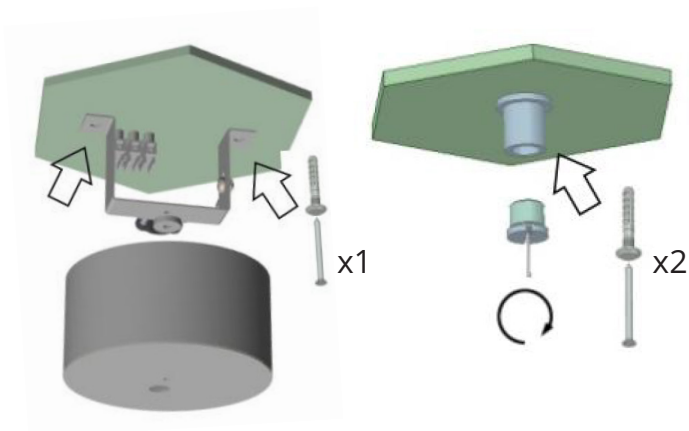

2.

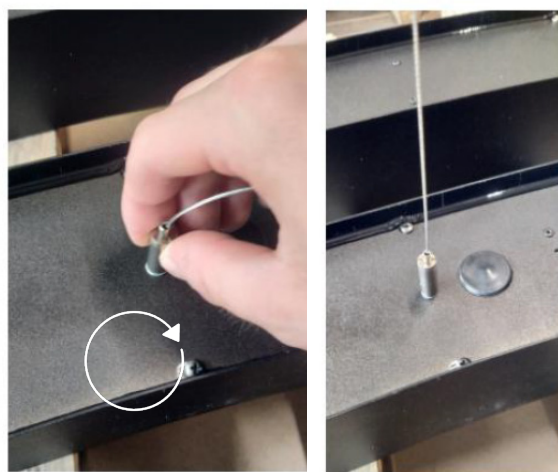

- 3.
- |          |  |                        |
|----------|--|------------------------|
| Blå      |  | = Nolla                |
| Brun     |  | = Fas                  |
| Grön/Gul |  | = Jord                 |
| Svart    |  | = DALI DA- (Fasimpuls) |
| Vit      |  | = DALI DA+             |

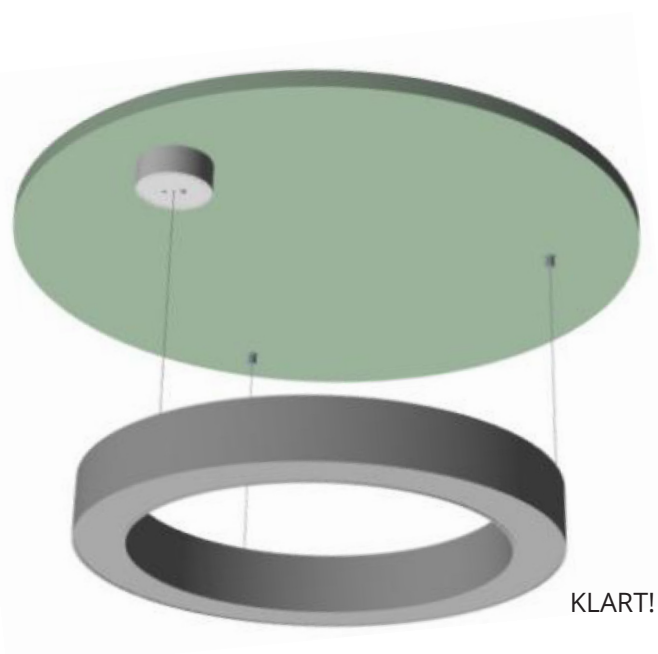

# Måttskiss Solea C & Solea Ring C

## Solea C

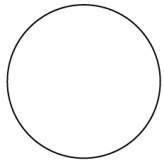
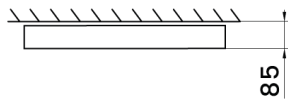
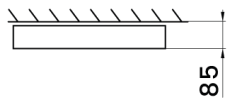

Ø 650

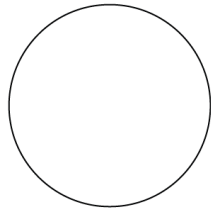

Ø 900

## Solea Ring C

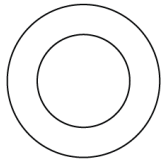
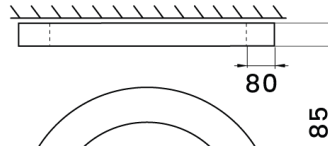
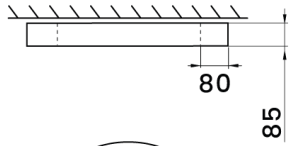
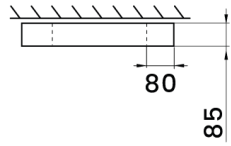

Ø620

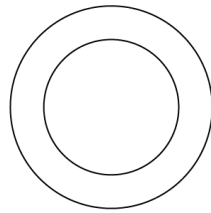

Ø 900

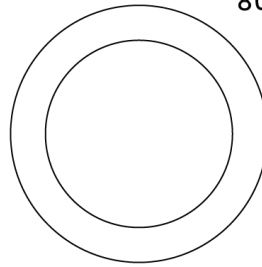

Ø1200

# Montage Solea C & Solea Ring C



OBS! Stäng av huvudströmmen innan installation.

1. Placera takdelen i taket och gör markeringar i taket för infästningspunkterna
2. Montera upp takdelen med skruv och plugg som är anpassade för taket.
3. Montera säkerhetswiren i takdelen och armaturhuset.
4. Anslut kabeln. Blå = Nolla, Brun = Fas, Grön/Gul = Jord, Vit och Svart = DALI
5. Montera upp armaturhuset i takdelen. OBS! Tryck ej på bländskyddet.

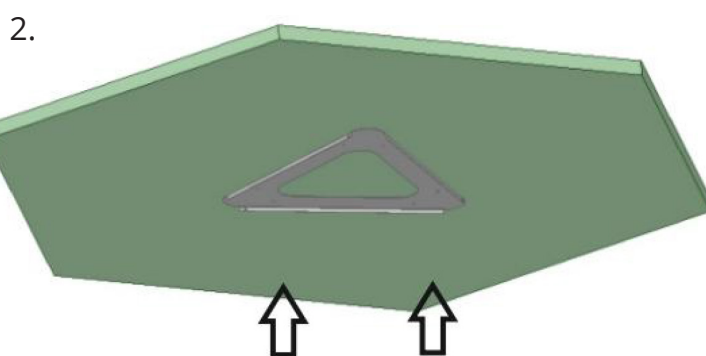
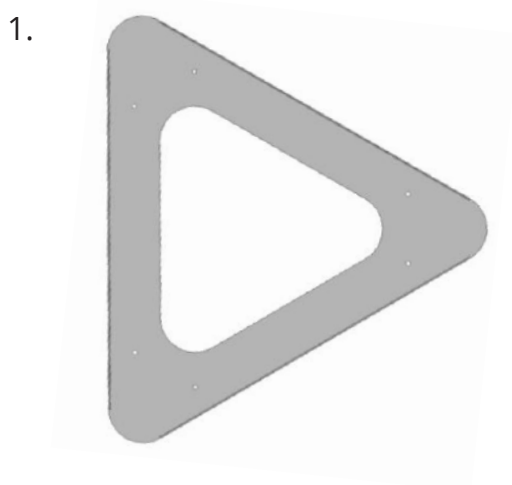

- 4.
- |          |  |              |
|----------|--|--------------|
| Blå      |  | = Nolla      |
| Brun     |  | = Fas        |
| Grön/Gul |  | = Jord       |
| Svart    |  | = DA- (DALI) |
| Vit      |  | = DA+ (DALI) |

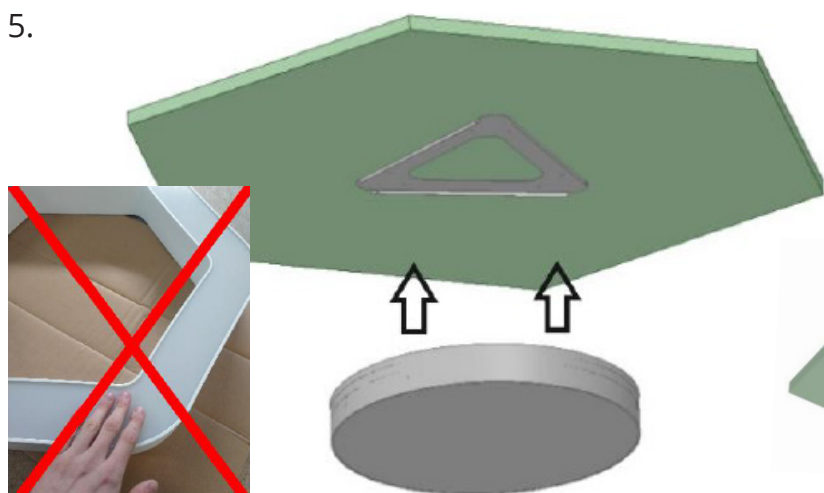

Tryck ej på bländskyddet

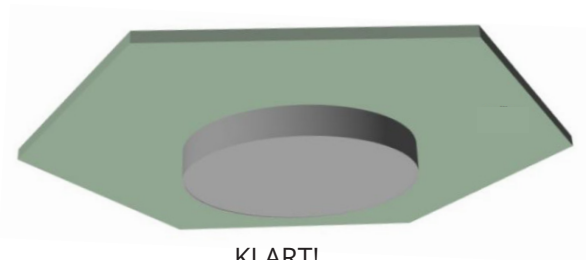

KLART!



SKANNA MIG!





# Underhåll

Vid behov avtorkas armaturen med antistatisk duk

**ecolux**