



MONTAGEANVISNING

BAT CEILING/CORRIDOR/COMPACT

Datum		2010-02-11	
Ritad	BS	Godk.	JEK
Dokumentnr.	0449-401	Rev.	4

Håltagning för kabel och upphäng

CEILING/CORRIDOR

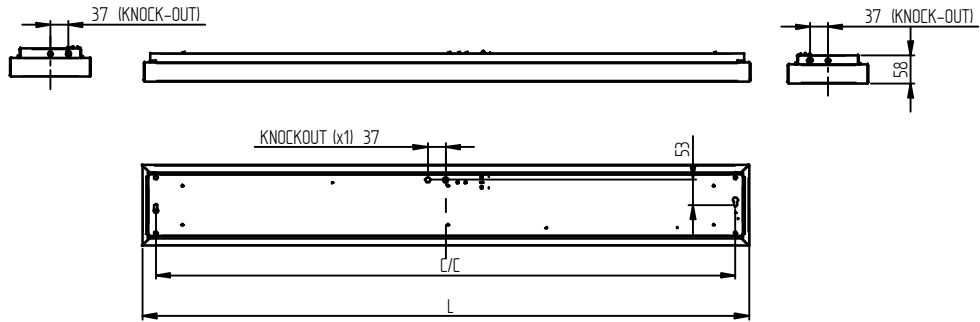

Effekt/Wattage	L (mm)	C/C
14,24W	656	600
28W	1256	1200
35,49W	1556	1200

COMPACT

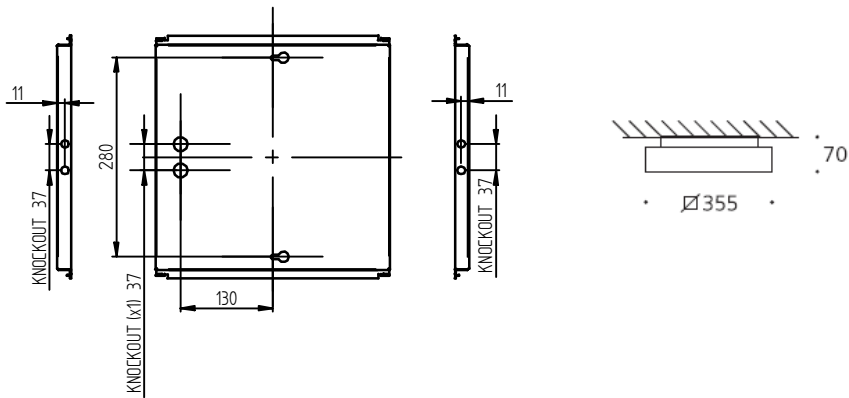

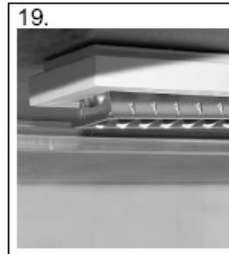
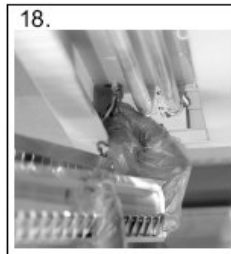
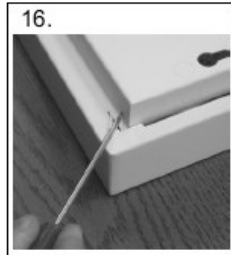
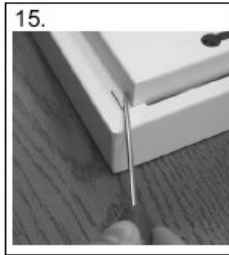
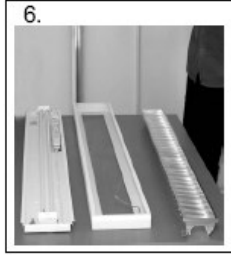
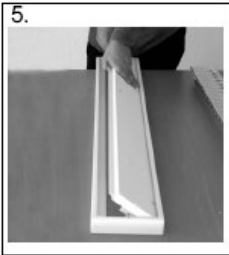
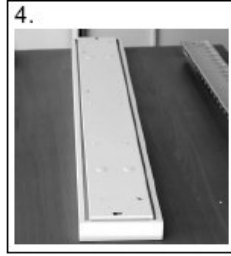
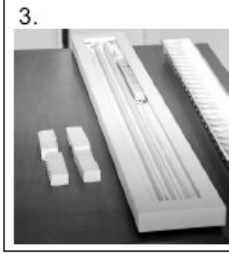
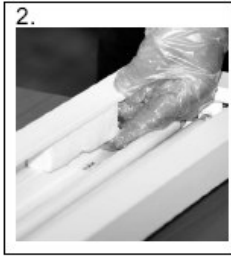

SECTION A-A

CORRIDOR

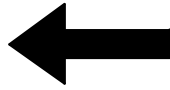
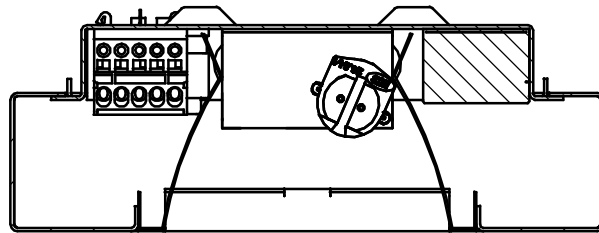

LJUSRIKTNING